

# ***Pro2-Series 3D Printer***

## Quick Start Guide

\* Please review this entire guide before operating the printer.

### **WARNING**

This is a class A product. In a domestic environment this product may cause radio interference in which case the user may be required to take adequate measures.

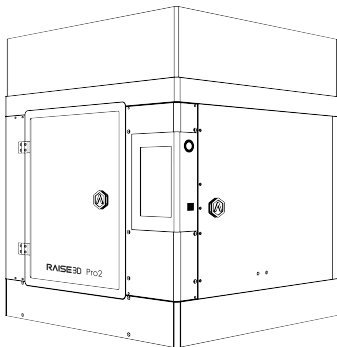

**Pro2**

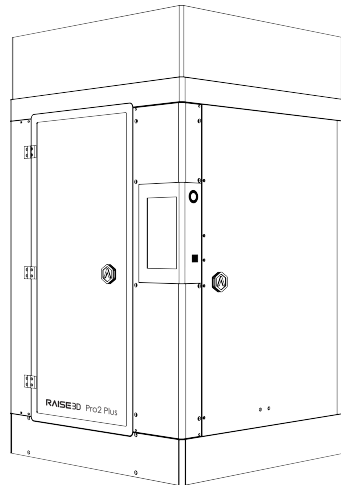

**Pro2 Plus**



---

The contents of this Quick Start Guide may be updated over time. For the latest version, scan the QR code or visit the link below.



[www.raise3d.com/pages/download#down-quickguide](http://www.raise3d.com/pages/download#down-quickguide)

# A. List of Parts

## Pro2

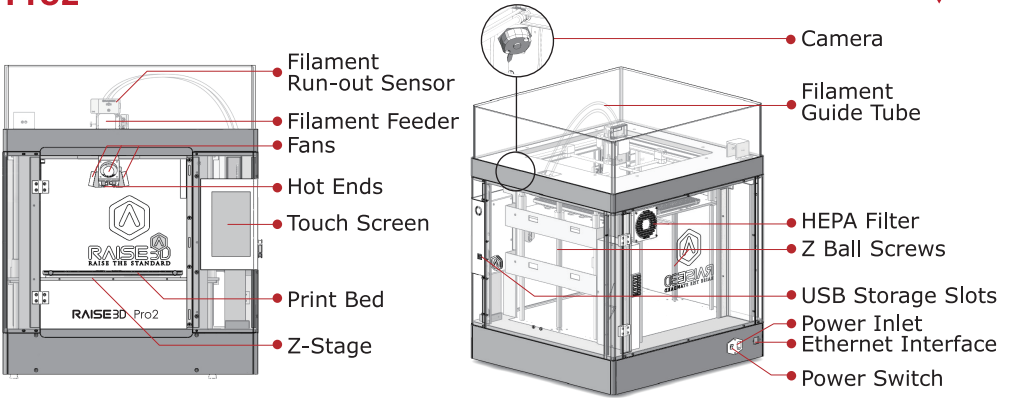

## Pro2 Plus

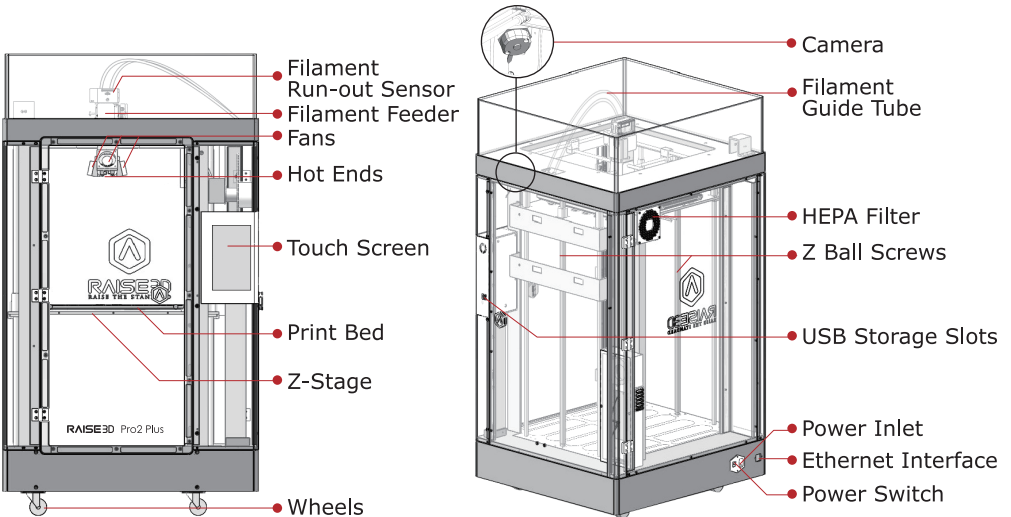

## B. Hardware Installation

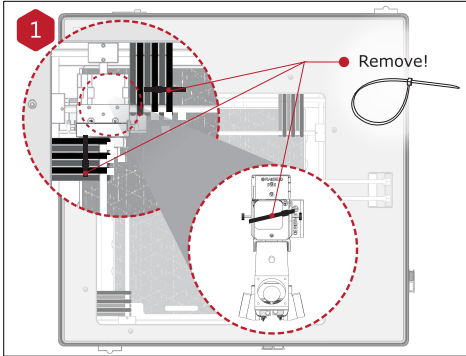

Locate the four shipping zip ties, and remove them. It's recommend to unclip these as opposed to cutting. They can be reused if you need to transport your machine in the future.

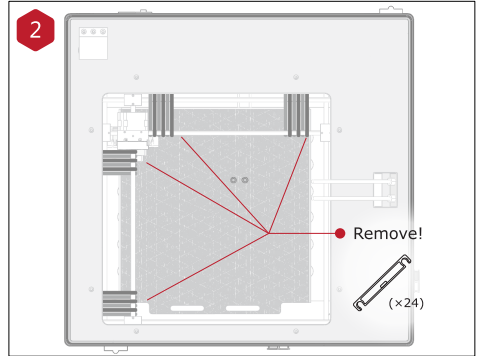

Peel the yellow sticker and remove the 24 security spacers. These clips are designed to hold the extruder assembly in place during shipping and should be saved for future transport. Do not operate printer with clips installed.

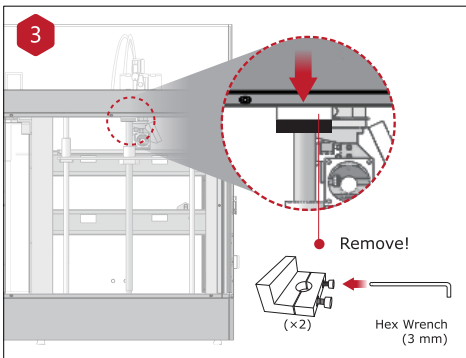

Select the largest of the included hex head wrench (3mm), and remove all four hex head security bolts from Z-axis clamps (2 bolts each). These are located on the left and right sides on the printer on the ball screw thread.

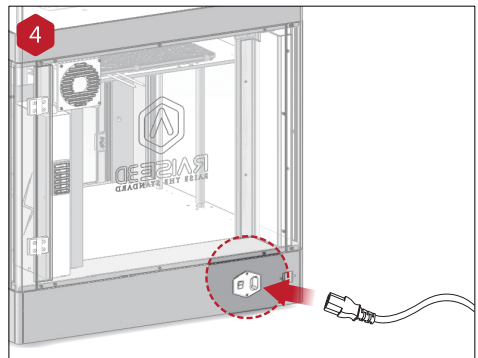

Plug the machine into a wall outlet using the power adapter for your designated country. (5 included) Flip the switch to power the unit on.

## B. Hardware Installation (continued)

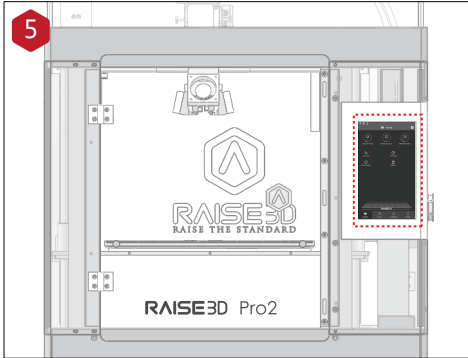

Once the unit has been powered, the printer will go through a start-up sequence. Your Raise3D printer will take approximately 60 seconds to boot up. When the touch screen displays the "Home" screen, the printer is ready.

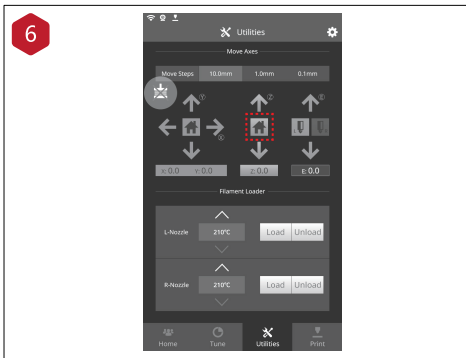

Open the "Utilities" tab, and press the Z Homing button. OK the request, and the print bed will begin to "home" or move to the origin position. This will also allow you to access your accessory packages.

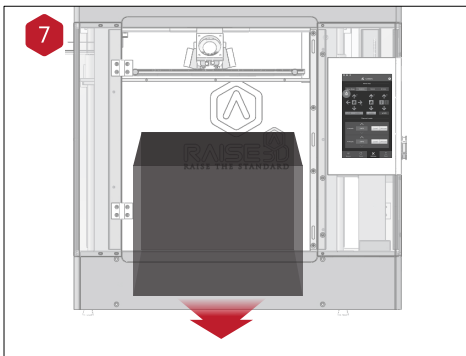

Open the front door, and remove the starter box and filament box from the base of the printer. Open these packages, and compare with the following contents list.

## B. Hardware Installation (continued)

### List of Contents



Power Cable  
(x5)



Hex Wrenches

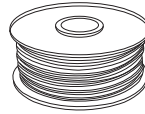

Filament  
(x2)

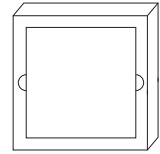

Build Plate  
(with Build Surface  
inside Protective Cover)



USB Storage



Heat Resistant Gloves



Filament Holder  
(x2)



Spatula



Nozzle  
Cleaning Kit



Tweezers



Fuse



Thumb Screws  
(Spare)



Other Accessories  
(Spare)

## B. Hardware Installation (continued)

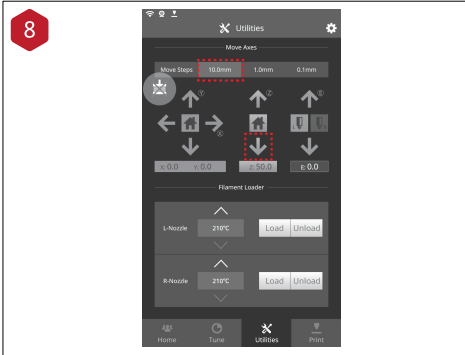

Lower the Z platform by 50mm. To do this, set the interval at "10mm" by selecting it in the "Move Steps" bar. This will move the bed 10mm per arrow click. Click this downward arrow 5 times to move Z platform downward to 50mm.

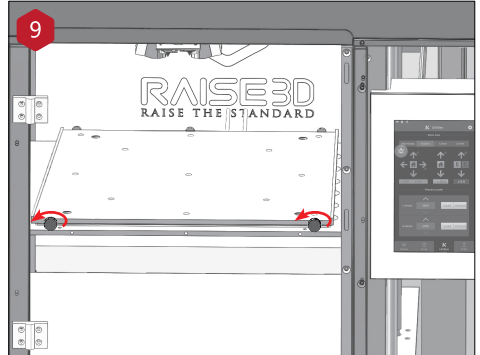

Loose the two thumb screws on the Z platform by rotating the two thumbscrews counter-clockwise.

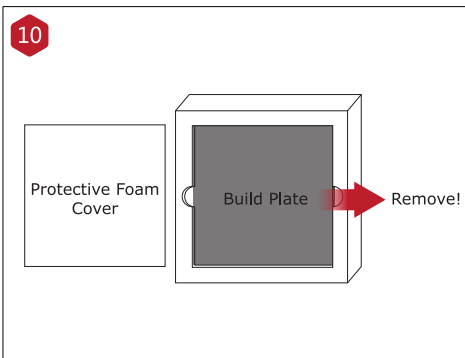

Remove the aluminum build plate from the foam packaging.

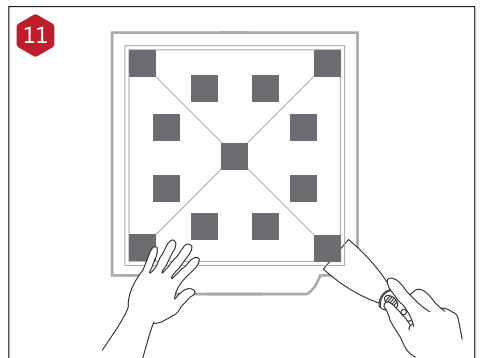

Using the included spatula, remove the leveling calibration model from your build plate.

## B. Hardware Installation (continued)

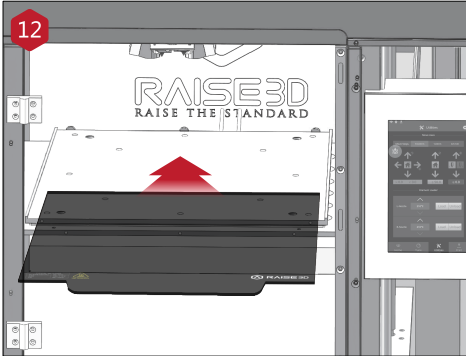

Slide the build plate onto the Z platform with the logos facing upwards, and the handle edge facing the front of the machine.

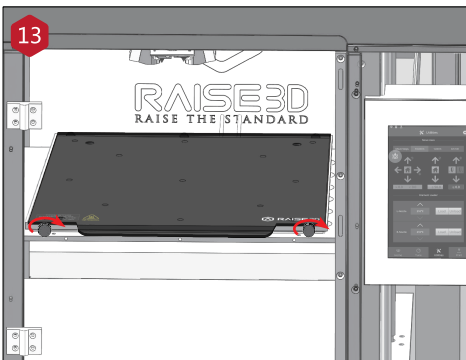

Re-install the thumb screws, rotating clockwise, to lock the build plate into position.

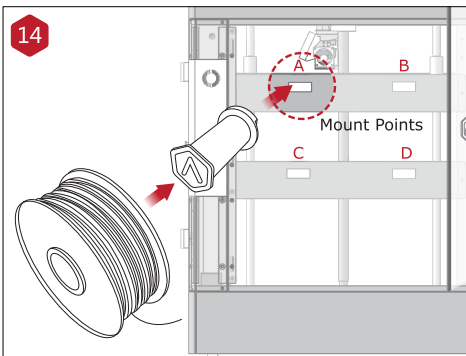

Open the side door of the printer, and install the filament holders into the mounting points. Open one of the included spools of filament, and place it on the holder.

**NOTE:** The direction of filament spool should be placed to rotate in clockwise at points B and D, and should be oriented to rotate counterclockwise at mount points A and C.



## B. Hardware Installation (continued)

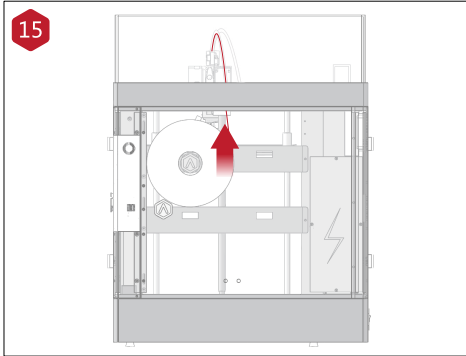

Locate the open end of the filament, and feed it through the guide tube.

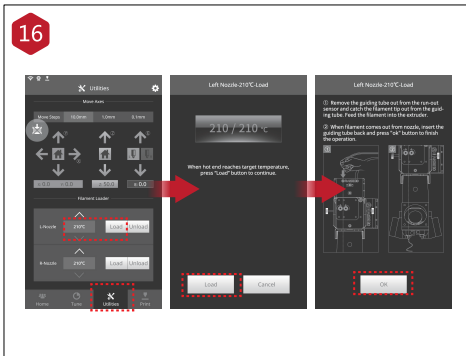

Press the "Utilities" tab on the screen and set the temperature of the left nozzle for the filament that you're using.

Press the "Load" button and the printer will begin to heat. When the target temperature is reached, press "Load". Complete the feeding operation according to the instructions on the screen.

**NOTE:** This document's instructions are based on the properties of Raise3D PLA filament. This is the standard filament included with your product and it is advised to use the Raise3D PLA for testing and initial setup.

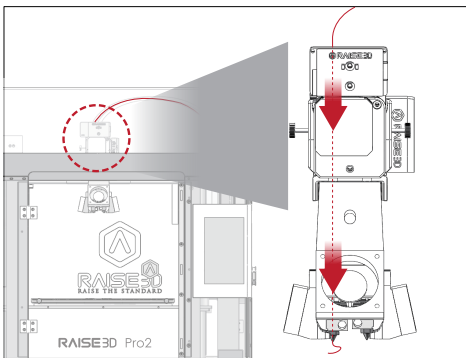

## C. ideaMaker Installation

The ideaMaker slicing software is available on the USB storage drive included with your printer.

Additional downloads and versions are available online at:  
[www.raise3d.com/pages/download](http://www.raise3d.com/pages/download)

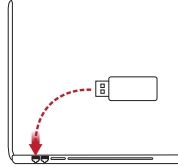

### WINDOWS

- 1 Open the installer and choose your preferred language. Select the installation location for ideaMaker, and click "Next".

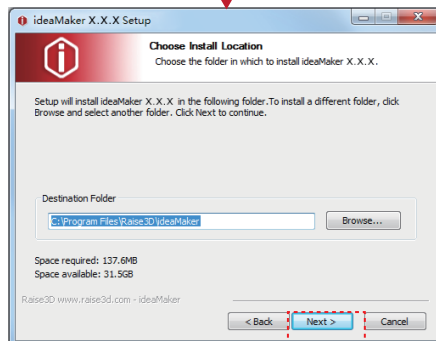

## C. ideaMaker Installation (continued)

- 2 Follow the instructions provided by the console, and click "Install". After the installation is finished, click "Next" to go to the next step.

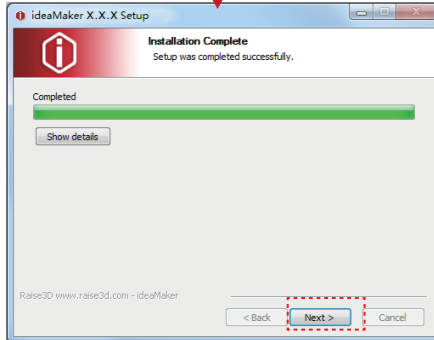
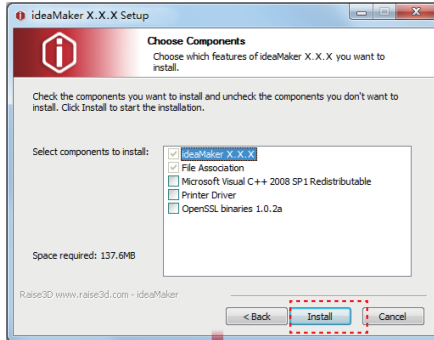

- 3 Click "Finish" and ideaMaker is installed.

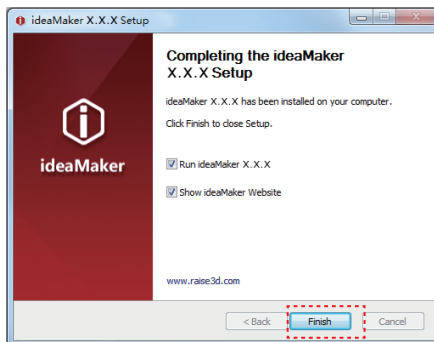

## C. ideaMaker Installation (continued)



### MAC OS X

Open the Disk Image for the ideaMaker installer. This is located in the USB storage drive included with your printer, or download the latest version from [www.raise3d.com/pages/download#down-im](http://www.raise3d.com/pages/download#down-im).

Drag the ideaMaker icon(left) into the Application folder on the right side.



## D. ideaMaker Initial Settings

- 1 When launching ideaMaker for the first time you, you will need to select your printer model from the drop-down list, then press "Next".

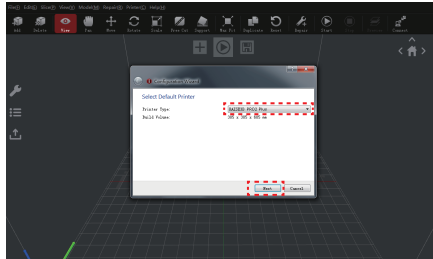

- 2 Select the diameter of your filament. Press "Finish" to finalize the initial settings.  
*NOTE: ALL Pro2-Series printers use 1.75mm filaments.*

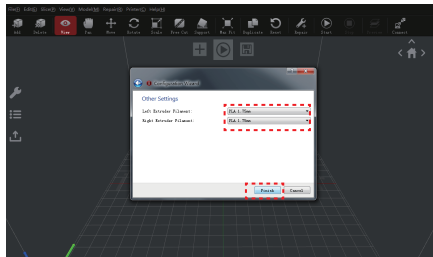

## E. Using ideaMaker

- 1 Click the "+" button to import "Giveaway Spinner" included in the USB storage.

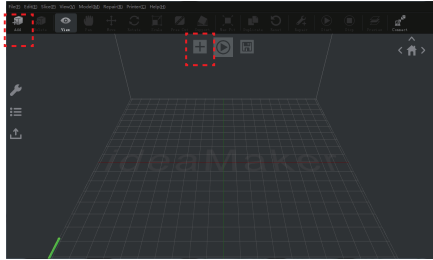

- 2 Click the "Start" or "▶" button to begin slicing the model.

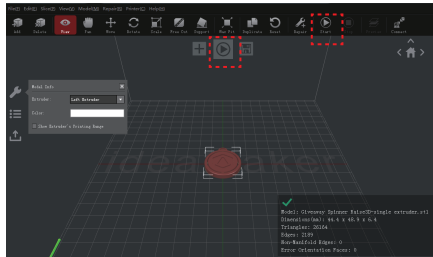

- 3 Confirm your printer type and material are correct, then select the standard slicing template.

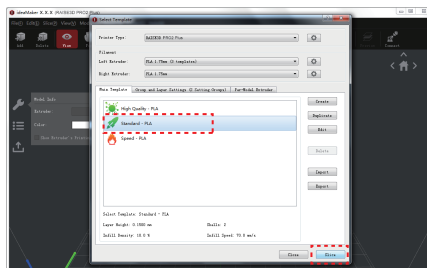

## E. Using ideaMaker (continued)

- 4 Select your type of Platform Addition and Support in the "Edit" window. Click "Save and Close" to return to the previous menu. Click "Slice" to generate your file.

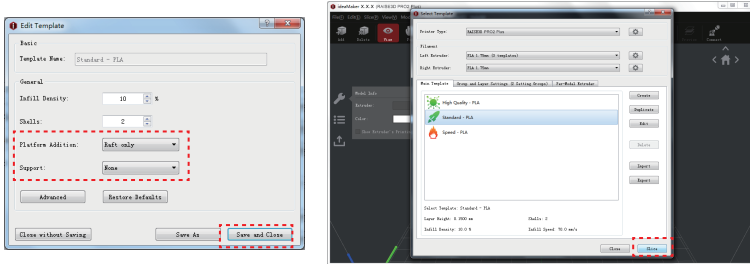

- 5 Save the sliced files (.gcode and .data) by exporting to the USB storage drive. *NOTE: File names that do not conform to the Western Latin character set may not display properly.*

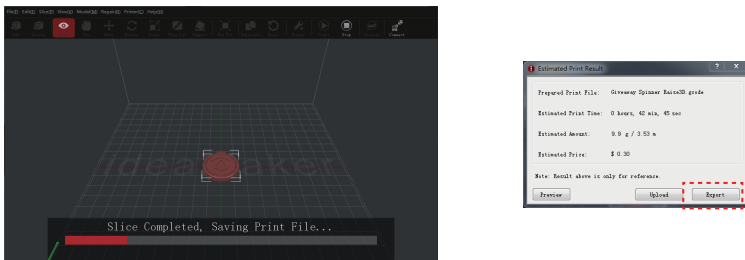

- 6 Confirm that the files are saved and eject the USB storage.



## F. Start First Print

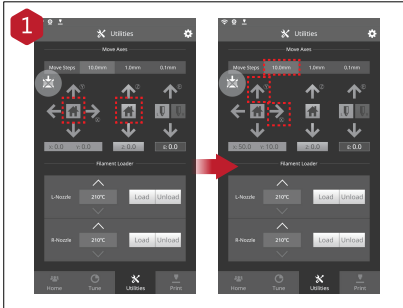

The Pro2/Pro2 Plus units are prelevelled in the factory, but we recommend verifying that the leveling has not changed during shipping.

First, home the X/Y Axis by selecting the "home" button, then Z axis "home" button. If the homing procedures complete without issues, reposition the print head.

Select "10mm" for "Move Steps" and move X to 50mm, Y to 10mm.

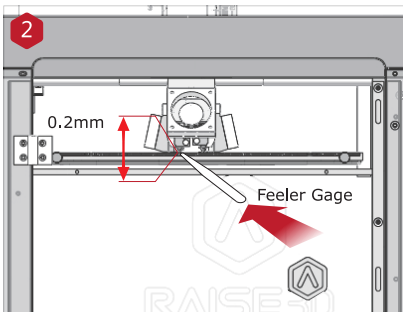

Please use the feeler gauge to check the distance between nozzle and printing platform. The optimal distance between is 0.2mm.

The best condition of this is that you can feel a little friction when you slide the feeler gauge into the gap.

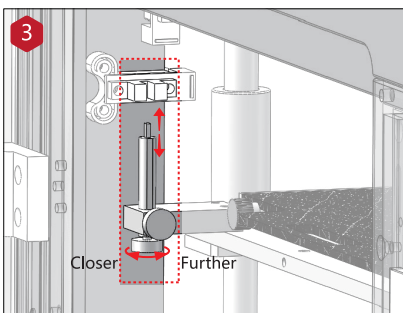

The distance between the nozzle and the printing platform can be adjusted by turning the thumb screw on the left-front corner of the Z-plate, the higher the screw stands out, the further the distance between the nozzle to the printing platform gets.



## F. Start First Print (continued)

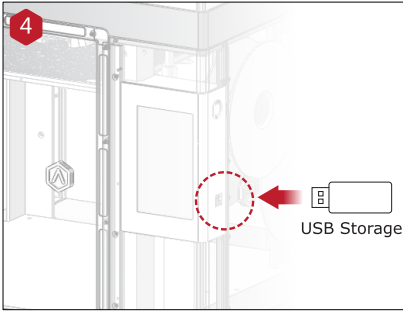

Insert the USB storage that contains your sliced model (.gcode and .data files).

Insert this USB drive into the USB slot on the side of touchscreen.

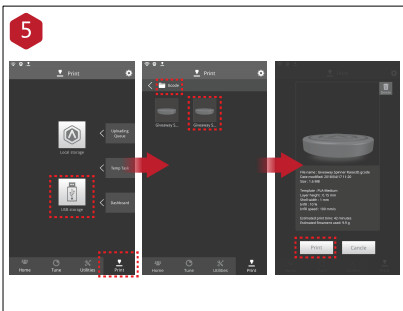

Select the "Print" tab, and choose "USB Storage". Select the file and check the printing parameters and settings. Press "Print" to start printing the test file.

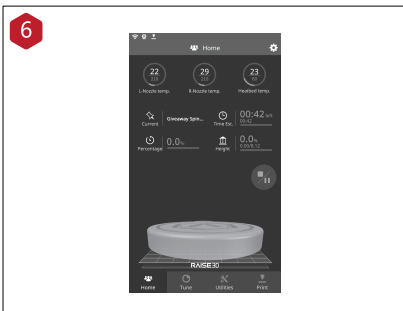

During printing, you can check the status of your print including printing time remaining and other parameters from the touchscreen in the "Home" interface.

**NOTE:** The touch screen will display an image of your model on-screen during printing. This image will only be shown when the file is sliced by ideaMaker and the .data file is saved in USB storage or uploaded to screen.

# G. User Interface

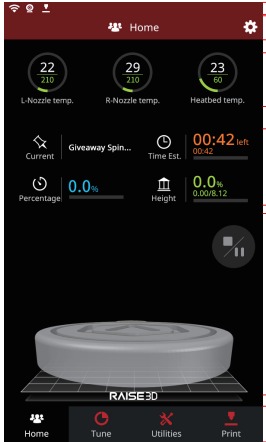

- Status bar
- Menu title, Settings Button
- Extruder and Heat Bed temperature
- Current model name, total print time, current printing status and height
- Visual display of current model
- Pause/Resume button
- Stop button
- Taskbar

Home

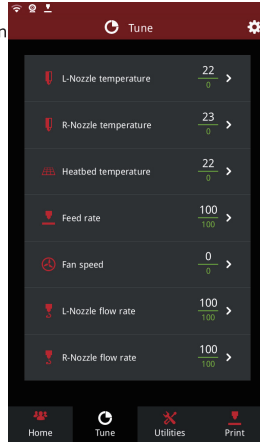

- Printing parameters and adjustment

Tune



- Moving step distance setting
- Disable motor button
- X/Y/Z axes move/return to original position
- Load and unload function for the L&R extruders.

Utilities

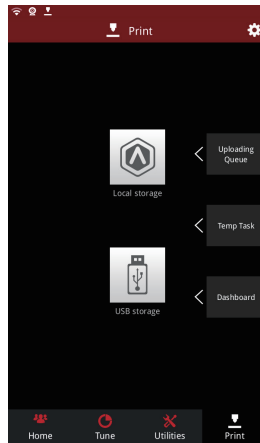

- Choose where to load the print job from
- Check uploading list, recovery task list, printing statistics

Print

## H. Dual-Extruder Print - Slicing

- 1 Open ideaMaker, Click the "+" button to import your two models (.stl file or .obj formats). You can download a file or use the test model included in the USB storage drive.

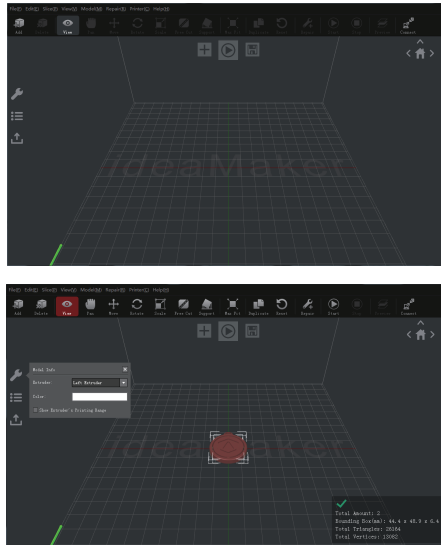

- 2 Choose one of the models and set its designated Extruder as Left Extruder from the left side 'Model Info' window.

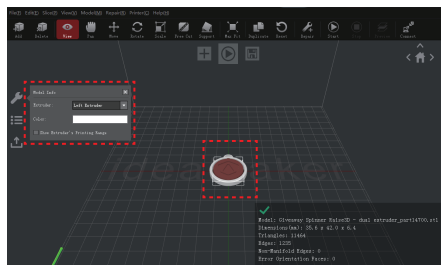

## H. Dual-Extruder Print - Slicing (continued)

- 3 Choose the other model and set Extruder as the Right Extruder using the 'Model Info' window.

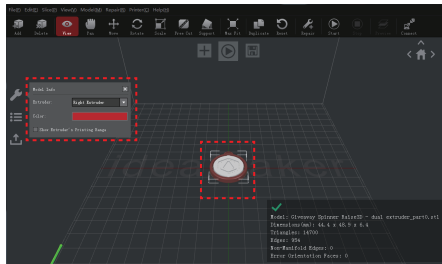

- 4 Click the "Start" or "i" button to begin the slicing of the model.

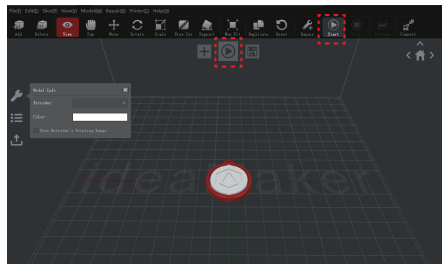

- 5 Confirm your printer type and materials for both extruders, then select the standard slicing template.

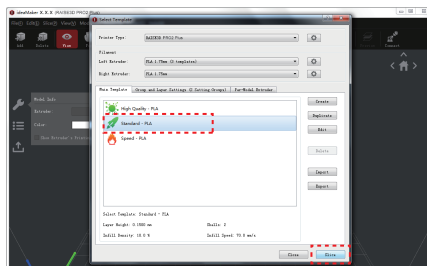

## H. Dual-Extruder Print - Slicing (continued)

- 6 Select your type of Platform and Support in the "Edit" window. Click "Save and Close" to return to the previous menu. Click "Slice" to generate your file.

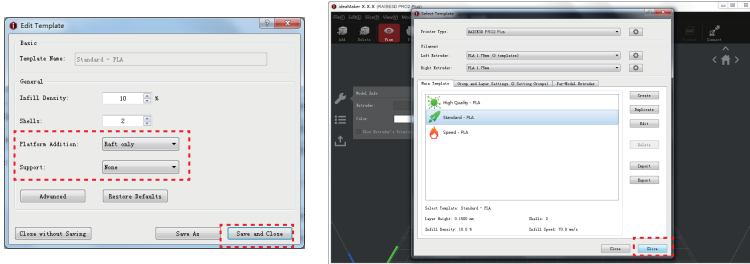

- 7 Save the sliced files (.gcode and .data) to your USB storage drive.  
*NOTE: File names that do not conform to the Western Latin character set may not display properly.*

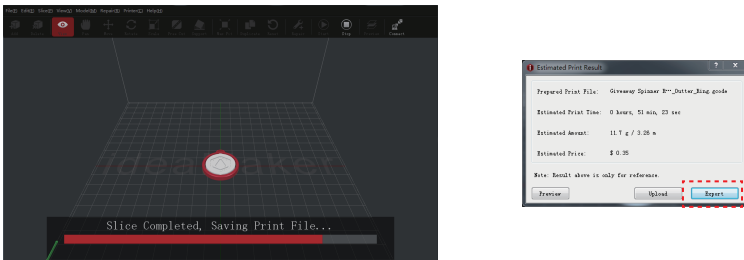

- 8 Confirm that the files are saved and eject the USB storage.



## H. Dual-Extruder Print - Hardware Installation

The following steps show how to feed the right nozzle. For the other hardware installations steps please see with Part **B. Hardware Installation** in this guide.

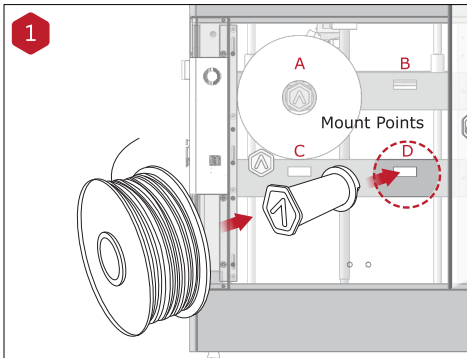

Install the filament holder in the mount point on the side of the printer and place a spool of filament on the holder.

**NOTE:** The direction of filament spool should be placed to rotate in clockwise at mount points B and D and counterclockwise at mount points A and C.

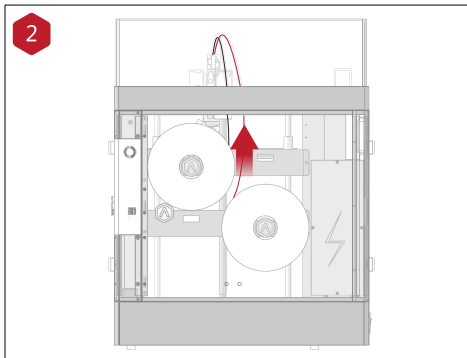

Feed the filament through the guide tube.

# H. Dual-Extruder Print - Hardware Installation (continued)

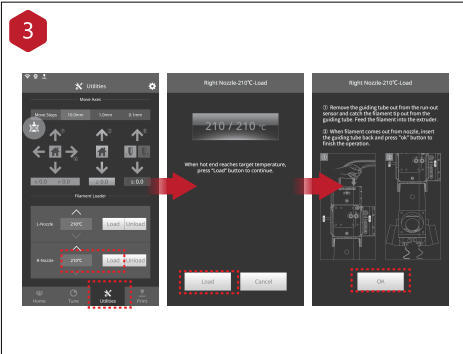

Open the “Utilities” tab on the screen and set the temperature of the right nozzle for the filament you're using, then press the “Load” button.

Finish the feeding operation step by step according to the instructions on the screen.

**NOTE:** This document is set based on the Raise3D PLA filament, delivered with the printer. We advise that using the Raise3D PLA for this initial setup and testing.

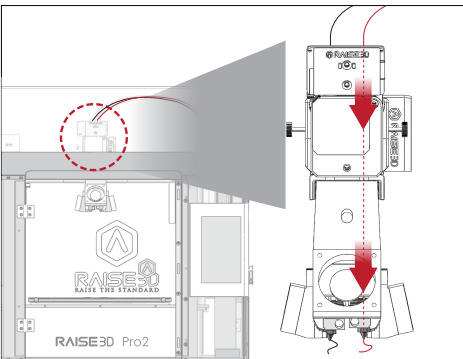

## H. Dual-Extruder Print - Start First Print

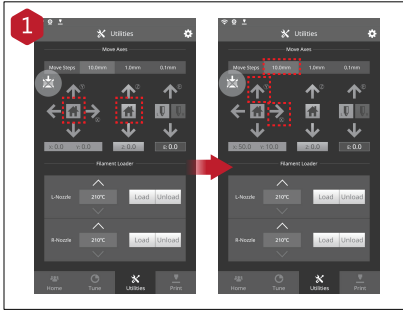

The Pro2/Pro2 Plus units are preleveled in the factory, but we recommend verifying that the leveling has not changed during shipping.

First, home the X/Y Axis by selecting the "home" button, then Z axis "home" button. If the homing procedures complete without issues, reposition the print head.

Select "10mm" for "Move Steps" and move X to 50mm, Y to 10mm.

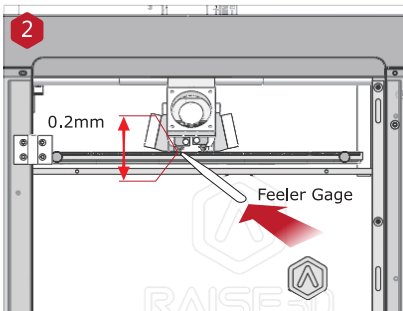

Please use the feeler gauge to check the distance between nozzle and printing platform. The optimal distance between is 0.2mm.

The best condition of this is that you can feel a little friction when you slide the feeler gauge into the gap.

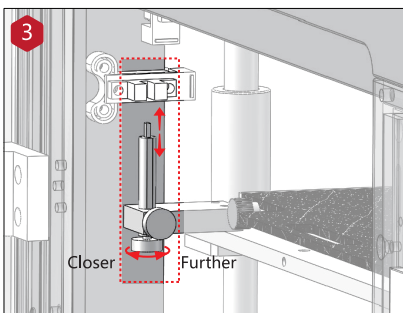

The distance between the nozzle and the printing platform can be adjusted by turning the thumb screw on the left-front corner of the Z-plate, the higher the screw stands, the further the distance between the nozzle will be from the printing platform.

Home the Z axis after each adjustment.



## H. Dual-Extruder Print - Start First Print (continued)

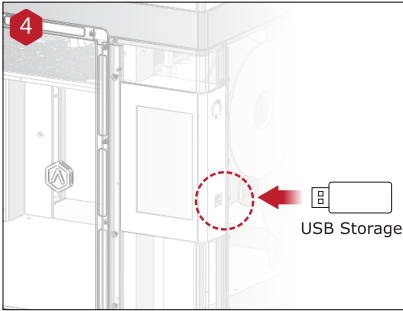

Insert the USB storage that contains your sliced model (.gcode and .data files).

Insert this USB drive into the USB slot on the side of touchscreen.

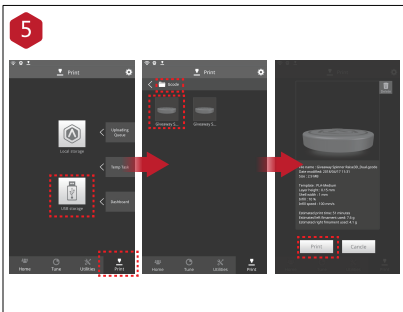

Open the "Print" tab, and choose "USB Storage" to open the file storage path. Select your dual extrusion file to check the printing parameters and settings. Press "Print" to start printing test file.

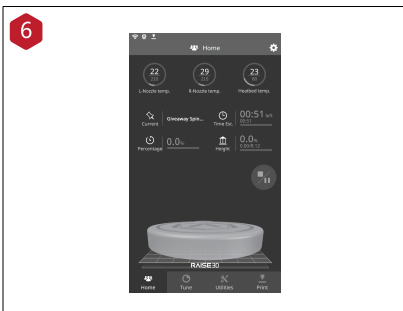

During printing, you can check the status of your model including the remaining printing time and other parameters from the "Home" interface on the touchscreen.

**NOTE:** The touch screen will display an image of your model on-screen during printing. This image will only be shown when the file is sliced by ideaMaker and the .data file is saved in USB storage or uploaded to screen.

# Technical Specifications

ITEM	Pro2		Pro2 Plus	
CONSTRUCTION	Build Volume (W×D×H)			
	Single Print	Dual Print	Single Print	Dual Print
	12×12×11.8 inch 305×305×300 mm	11×12×11.8 inch 280×305×300 mm *	12×12×23.8 inch 305×305×605 mm	11×12×23.8 inch 280×305×605 mm *
	Machine Size (W×D×H)			
	24.4×23.2×29.9 inch 620×590×760 mm		24.4×23.2×43.5 inch 620×590×1105 mm	
ELECTRICAL	Power Supply Input Power Supply Output		Universal 100-240 VAC, 50/60 Hz 600 Watts, 24 VDC	
PRINTER	Print Technology Print Head Filament Diameter XYZ Step Size Print Head Travel Speed Build Plate Max Build Plate Temperature Build Plate Material Build Plate Leveling Supported Materials		FFF Dual-head with electronic lifting system 1.75mm 0.78125, 0.78125, 0.078125 micron 30 - 150 mm/s Heated aluminum build plate with magnetic holding 110 °C Silicone Pre-calibrated leveling PLA/ ABS/ HIPS/ PC/ TPU/ TPE/ NYLON/ PETG/ ASA/ PP/ Glass Fiber Filled/ Carbon Fiber Enforced/ Metal Particles Filled / Wood Filled	
	Nozzle Diameter Max Nozzle Temperature Connectivity Monitoring Operating Sound Operating Ambient Temperature		0.2/ 0.4/ 0.6/ 0.8mm 300 °C Wi-Fi, LAN, USB port Live camera 50 dB 15 - 30 °C, 10 - 90% RH non-condensing	
SOFTWARE	Slicing Software Supported File Types Supported OS Machine Code Type		ideaMaker STL, OBJ WINDOWS/ IOS/ LINUX GCODE	
PRINTER CONTROLLER	User Interface Network Resume Print after Power Outage Screen Resolution Motion Controller Logic Controller Memory Onboard Flash OS Ports		7 inch Touch Screen Ethernet 802.11b/g/n Wifi 2.4GHz/5GHz Second Generation 1024*600 ATM Cortex M7.400MHZ FPU 32 bit freescale imx6, Quad core 1Ghz ARM processor 1GB 8GB Embedded Linux Sdcard*1, Usb2.0*2, Ethernet*1	

\*: When you are printing with dual Material.

---

## Experiencing Difficulties?

If you run into any issues during the guided setup, please contact our expert technicians by opening a ticket online at: <http://help.raise3d.com>.



# RAISE3D

---

🏠 4th Floor, Building B5, 1600 North Guoquan Rd, Shanghai, China 200438  
☎ +86 21 65337855

🏠 3189 Airway Avenue, Unit F, Costa Mesa, CA 92626, USA  
☎ +1 888 963 9028

🌐 [www.raise3d.com](http://www.raise3d.com)  
✉ [support@raise3d.com](mailto:support@raise3d.com)